



US009336693B2

(12) **United States Patent**
Segall

(10) **Patent No.:** **US 9,336,693 B2**
(45) **Date of Patent:** ***May 10, 2016**

(54) **WEARABLE PARTIAL TASK SURGICAL SIMULATOR**

(56) **References Cited**

U.S. PATENT DOCUMENTS

(71) Applicant: **Stuart Charles Segall**, San Diego, CA (US)
(72) Inventor: **Stuart Charles Segall**, San Diego, CA (US)
(*) Notice: Subject to any disclaimer, the term of this patent is extended or adjusted under 35 U.S.C. 154(b) by 0 days.
This patent is subject to a terminal disclaimer.

4,221,975	A *	9/1980	Ledniczki et al.	307/116
4,531,919	A	7/1985	Ware	
5,104,328	A *	4/1992	Lounsbury	434/273
5,305,181	A *	4/1994	Schultz	361/679.03
5,990,625	A *	11/1999	Meissner et al.	315/85
5,995,077	A *	11/1999	Wilcox et al.	715/841
6,057,540	A *	5/2000	Gordon et al.	250/221
6,984,208	B2 *	1/2006	Zheng	600/438
7,810,504	B2 *	10/2010	Guzman	128/897
7,850,456	B2 *	12/2010	Chosack	G09B 23/32 345/619
7,963,770	B2 *	6/2011	Kukora et al.	434/262
7,967,679	B2 *	6/2011	Ombrellaro	A63F 13/02 436/30
8,262,668	B2 *	9/2012	Biegun	606/99
8,840,403	B2 *	9/2014	Segall	G09B 23/28 434/272
2007/0243512	A1	10/2007	King	
2009/0246747	A1	10/2009	Buckman	
2009/0298034	A1	12/2009	Parry et al.	
2011/0060555	A1 *	3/2011	Koehler et al.	703/1

(21) Appl. No.: **14/494,490**

(22) Filed: **Sep. 23, 2014**

(65) **Prior Publication Data**
US 2015/0024363 A1 Jan. 22, 2015

Related U.S. Application Data

(62) Division of application No. 12/803,609, filed on Jun. 30, 2010, now Pat. No. 8,840,403.

(51) **Int. Cl.**
G09B 23/30 (2006.01)
G09B 23/28 (2006.01)

(52) **U.S. Cl.**
CPC **G09B 23/303** (2013.01); **G09B 23/28** (2013.01); **G09B 23/30** (2013.01)

(58) **Field of Classification Search**
CPC G09B 23/28
USPC 434/272
See application file for complete search history.

* cited by examiner

Primary Examiner — Michael Dennis
Assistant Examiner — Dolores Collins
(74) *Attorney, Agent, or Firm* — Gary L. Eastman, Esq.

(57) **ABSTRACT**

A wearable device for simulating wounds and injuries received during a trauma event includes a raiment and vest for covering the torso of a person. The raiment has an outer surface with a color and a texture comparable to human skin. Mounted on the outer surface is at least one wound simulator formed with an orifice that is in fluid communication with a fluid reservoir. Thus, the person can selectively expel a blood-like fluid from the reservoir, and through the wound simulator orifice, to simulate a trauma event. The vest includes an artificial rib cage and prosthetic internal organs juxtaposed with at least one wound simulator to simulate internal effects of a trauma event.

12 Claims, 5 Drawing Sheets

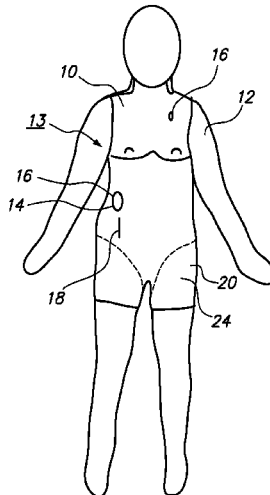

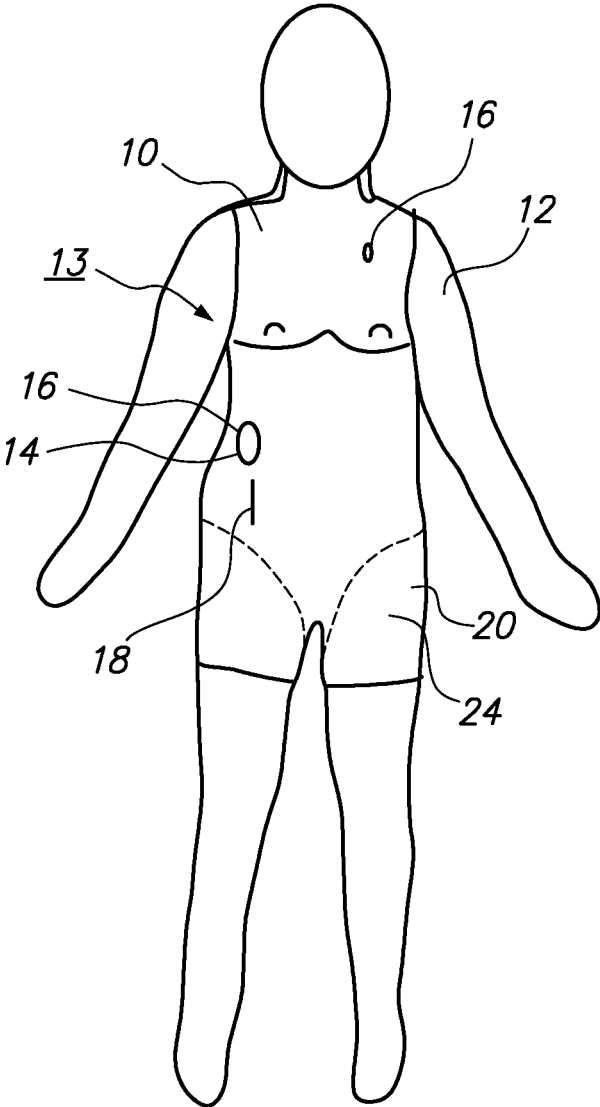

FIG. 1

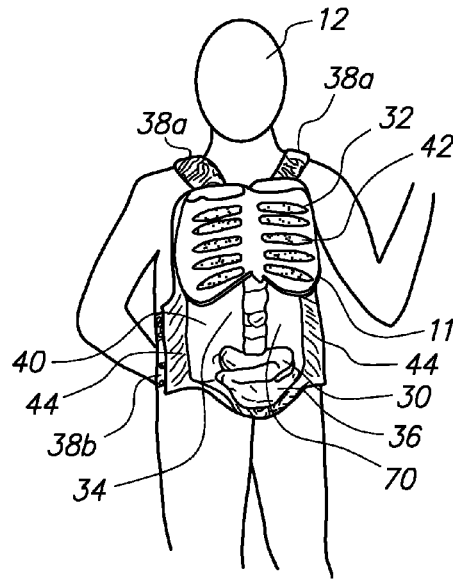

FIG. 2A

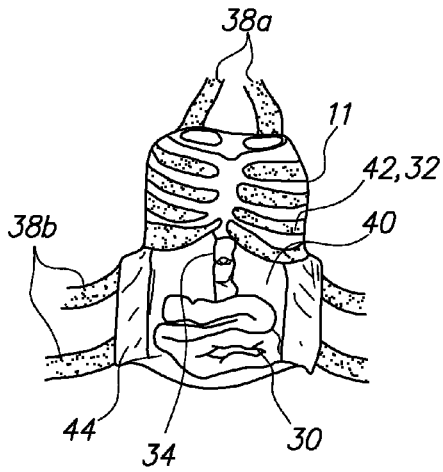

FIG. 2B

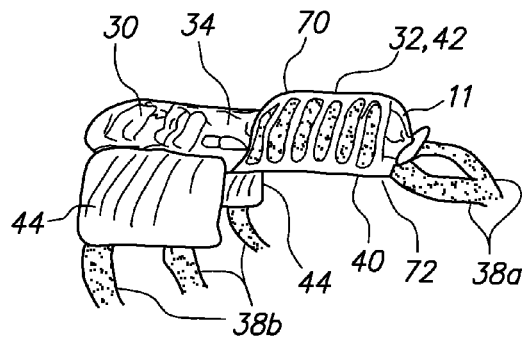

FIG. 2C

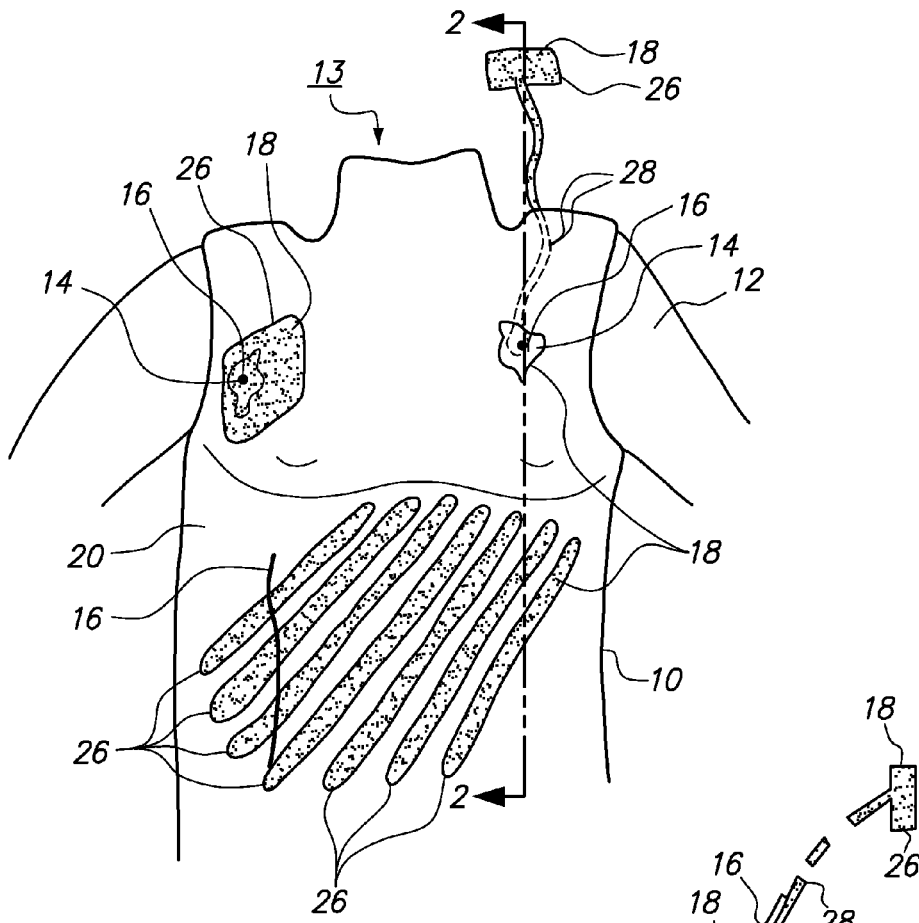

FIG. 3A

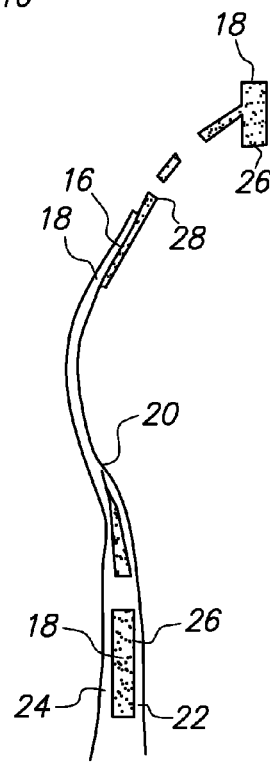

FIG. 3B

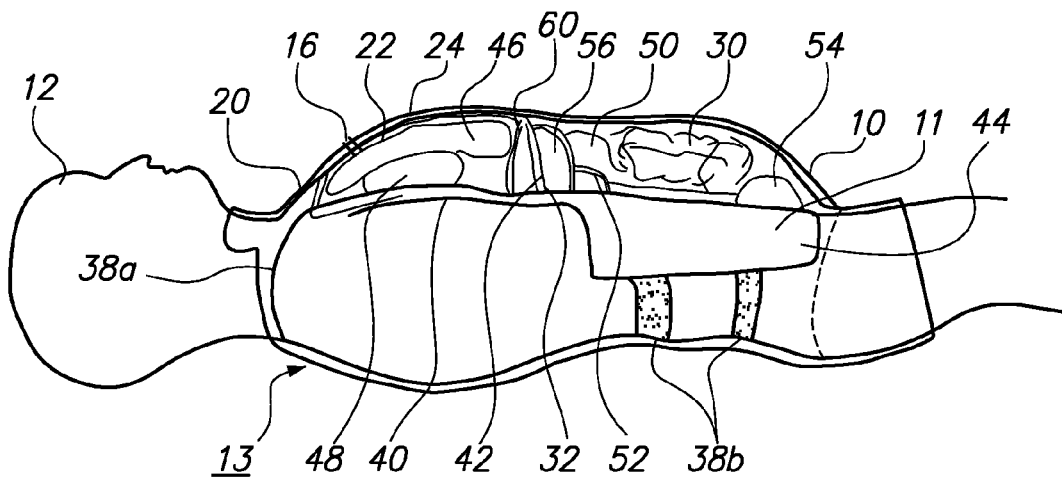

FIG. 4

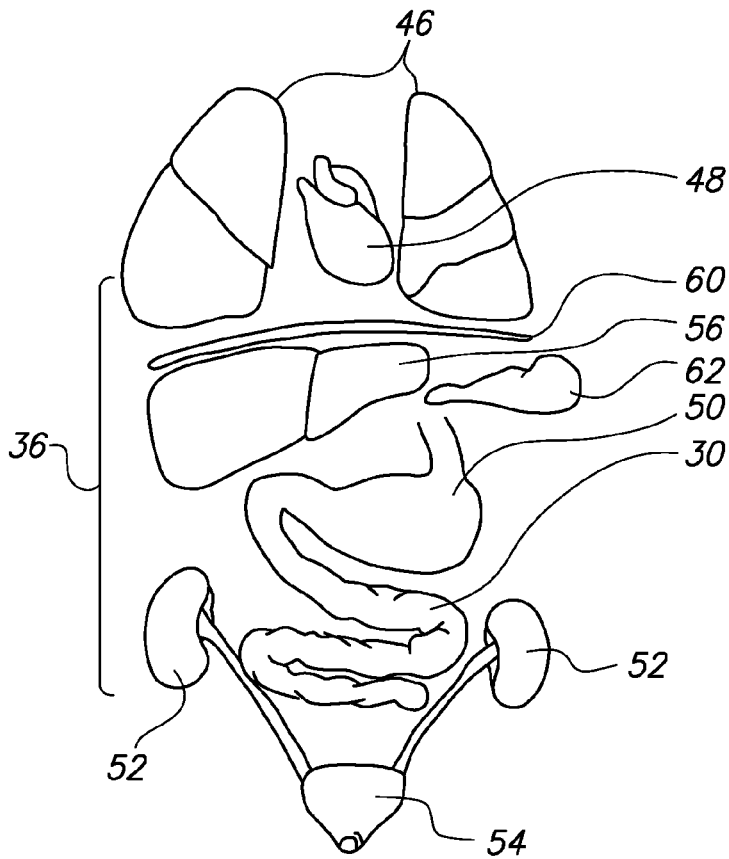

FIG. 5

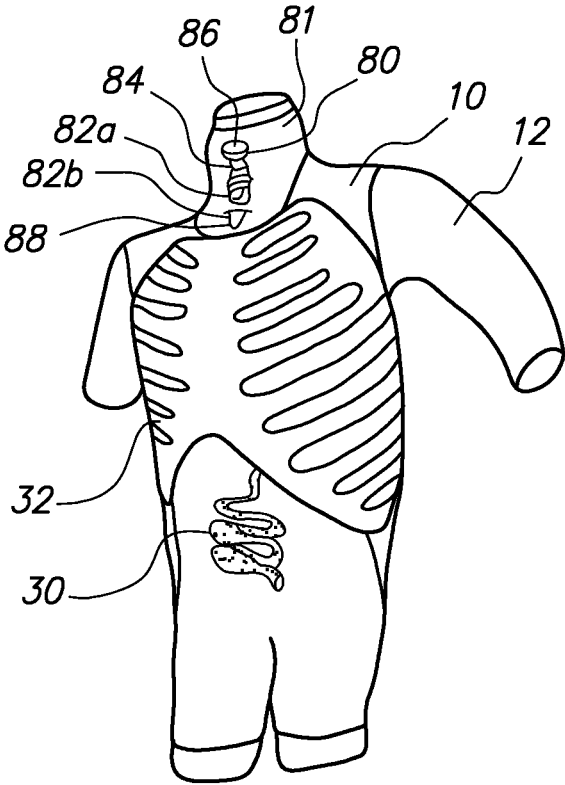

FIG. 6

1

**WEARABLE PARTIAL TASK SURGICAL
SIMULATOR**

RELATED APPLICATIONS

This application is a divisional of, and claims the benefit of priority to, the U.S. Utility patent application for "Wearable Partial Task Simulator", Ser. No. 12/803,609, filed on Jun. 30, 2010, and currently co-pending.

FIELD OF THE INVENTION

The present invention pertains generally to devices and methods for use in simulating the injurious effects of a traumatic event on a person. More particularly, the present invention pertains to devices and methods for simulating the wounds and injuries that a person may receive during such an event. The present invention is particularly, but not exclusively, useful as a training aid for providing realistic-looking medical effects to first responders, in a dynamic presentation, when practicing first aid on a person who has experienced trauma.

BACKGROUND OF THE INVENTION

As is well known, and widely accepted, partial task simulators and training aids can be very effective for teaching individuals how to perform a wide variety of different tasks. More specifically, they can be extremely helpful for teaching an individual how to perform certain medical procedures. In this context, and of particular importance for the present invention, are those medical procedures that are required for response to a life-threatening, emergency situation. The import here is two-fold. Firstly, the partial task simulator should effectively augment the educational background that is necessary to assess an emergency situation. Secondly, it should serve as a tool with which a person can learn how to respond to an emergency situation by properly performing essential life-saving tasks. The efficacy of any partial task simulator or training aid, however, is dependent on the realism it provides and its ability to simulate or mimic an environment where the task is to be actually performed.

With the above in mind, a catastrophic event presents a situation wherein the proper training of emergency medical personnel can be invaluable. Regardless whether the event is the result of an accident, a natural disaster or some form of combat, the consequence of a first response to the event may make the difference between life and death. In such instances, the ability of medical personnel to rapidly and reliably attend to wounds and injuries is of crucial importance. Practice on partial task simulators such as medical mannequins, while valuable as teaching aids, are limited by the mannequin's immobility, weight, expense and minimal interaction with the medical personnel.

In light of the above, it is an object of the present invention to provide a device for realistically and dynamically simulating the wounds and injuries on a person (e.g., role player, actor) that can be received during a traumatic event. Another object of the present invention is to provide a device that effectively functions as a training aid to teach a person how to treat the wounds and injuries that can be received by a person during a traumatic event. Another object of the present invention is to provide a device that effectively functions as a training aid that allows verbal and gesticular interaction between a live human wearing the device and a first responder who is treating the person wearing the device. Still another object of the present invention is to provide a training aid for

2

teaching how to treat wounds and injuries that is easy to use, is simple to manufacture and is comparatively cost effective.

SUMMARY OF THE INVENTION

5

In accordance with the present invention, a partial task surgical simulator (training aid device) is provided for simulating the wounds and injuries on a role player, actor or model that could be received by a person during a trauma event. Specifically, the device includes a raiment fitting over strapped vests that are dimensioned to cover the torso of a person and therefore be worn by a person in a simulation. Further, the raiment can extend over the person's shoulders and upper arms, as well as over his/her groin area and upper thighs. Structurally, the raiment is made primarily of silicone and nylon fiber, and it is formed as a layer having an inner surface and an outer surface, with the outer surface having a color and a texture that is comparable to human skin. The vest is designed to fit under the raiment and on the torso of a body. Structurally, the vest is made primarily of silicone, nylon fiber, plastic and rubber materials, and it is formed as a shield portion covering the front and side of the torso held in place by straps. The vest provides a protective layer between the raiment and the model or actor. The vest is further designed to provide a detail of the internal structure of a human body, such as the rib cage and internal organs. The vest forms a cavity generally under and below the rib cage in which such prosthetic internal organs can be placed. The importance of the invention is that the simulator presents first responders with realistic-looking, dynamic medical effects that can simulate and mimic a plurality of different wounds and injuries.

As part of the presentation for simulating a trauma event, the device of the present invention comprises a wound simulator that can be selectively attached to the outer surface of the raiment. The wound simulator can then simulate either surface or penetrating wounds and injuries. For example, the wound simulator can be used to simulate surface injuries such as burns, scrapes, abrasions, or the effects of chemical, biological or nuclear agents, or the result of internal injuries from punctures and other injuries. Additionally, the wound simulator can be used to simulate penetrating injuries such as high and low velocity missile wounds caused by gunshot, shrapnel, and blunt/sharp object penetration.

In order to provide added realism for the simulation of penetrating wounds, the raiment is formed with at least one orifice on its outer surface. Further, the raiment includes at least one fluid reservoir that is formed into the layer of the raiment, between its inner and outer surfaces. Specifically, the reservoir is provided for holding a blood-like fluid, and it is connected in fluid communication with the orifice. Thus, the person who is wearing the raiment can selectively expel the blood-like fluid from the reservoir and through the orifice, merely by squeezing the reservoir, to simulate bleeding. Depending on the particularly desired presentation, a wound simulator may be juxtaposed with the orifice to simulate bleeding from the wound.

In addition to the outward appearances of traumatic wounds and injuries mentioned above, the present invention also employs prosthetics to mimic certain internal organs and anatomical structures that may be affected by the trauma event. These prostheses are made of composite materials such as open or closed cell polyurethane foam of various densities, elasticity, and deformation characteristics to simulate internal organs. Specifically, these prostheses can be used to mimic torso injuries (e.g., abdominal, upper torso; as well as other injuries, such as thorax wounds/injuries).

For the simulation of penetrating wounds, the present invention includes access through the raiment, such as through an orifice, to internal organs within the cavity of the vest. Further, the orifice, wound simulators, reservoirs and internal organs are positioned and juxtaposed to simulate various injury scenarios, which may be selectively done. For example, the organs may include a predetermined length of flexible tubing that is comparable in appearance and texture to intestines. When used, this pseudo intestine is positioned between the vest and the inner surface of the raiment. Further, a portion of the pseudo intestine can be juxtaposed with at least one orifice in the raiment for use in simulating the penetrating abdominal wound within the torso cavity. Similar simulations can be used for various upper torso injuries (e.g., lungs, heart, kidneys, stomach, etc.).

BRIEF DESCRIPTION OF THE DRAWINGS

The novel features of this invention, as well as the invention itself, both as to its structure and its operation, will be best understood from the accompanying drawings, taken in conjunction with the accompanying description, in which similar reference characters refer to similar parts, and in which:

FIG. 1 is a front view of a raiment in accordance with the present invention mounted on a human body;

FIG. 2A is a perspective view of a vest in accordance with the present invention mounted on a human body;

FIG. 2B is a front view of a vest in accordance with the present invention;

FIG. 2C is a side view of a vest in accordance with the present invention;

FIG. 3A is a perspective view of the simulator of the present invention with cut away views to show internal features of the raiment;

FIG. 3B is a cross sectional view seen along line 2-2 in FIG. 3A;

FIG. 4 is side view of a simulator in accordance with the present invention mounted on a human body with a cut away view of the vest underneath the raiment;

FIG. 5 is an exploded view of prosthetic internal organs of the present invention; and

FIG. 6 is a perspective view of the prosthetic thorax of the invention.

DESCRIPTION OF THE PREFERRED EMBODIMENTS

Referring initially to FIG. 1, a simulator in accordance with the present invention is shown and designated 13. As shown, a raiment in accordance with the present invention is also shown and designated 10. As shown, the raiment 10 is dimensioned and fitted to cover a person 12 (e.g., person, role player, actor, model). As such, the raiment 10 is a base member of the simulator 13. More specifically, the raiment 10 is intended to be wearable by a person. Accordingly, it is intended to cover the torso of a person 12, and to extend over the shoulders, upper arms, groin area and upper thighs of the person 12. For purposes of this disclosure, the person 12 is shown in FIG. 1 to present these anatomical features. FIG. 1 also indicates that a wound simulator 14 can be used with the raiment 10, and that the raiment 10 can be formed with an orifice 16 from which a blood-like fluid 18 can be expelled. For example, the wound simulator 14 can be used to simulate surface injuries such as burns, scrapes, abrasions, radiation, or the result of internal injuries from punctures and other injuries. Additionally, the wound simulator 14 can be used to simulate penetrating injuries to the internal cavity of the

human torso. As further shown in FIG. 1 (and FIGS. 3A and 3B), blood-like fluid 18 may be expelled in various ways (e.g., patches, spots, drops, drips, puddles, ooze spots).

As further shown in FIG. 1, the raiment 10 is made of a layer 20 having an outer surface 24. Preferably, the layer 20 is made of a silicon material that contains nylon fibers. However, other materials may also be used, such as carbon fibers, other composite materials, latex and other rubber materials. In any event, the layer 20 must be sufficiently flexible to allow it to be worn by a person 12 as the person 12 moves to mimic the motions of a severely injured victim of a traumatic event. For this purpose, the outer surface 24 of the raiment 10 is preferably colored and textured to simulate human skin. In alternative embodiments, portions of inner layer 22 may be resin coated to protect the person 12 from being cut, such as by a surgical instrument in simulating trauma events and response to trauma events.

Referring to FIG. 2A, a vest in accordance with the present invention is also shown and designated 11. As shown, vest 11 is dimensioned to fit on the torso of a person 12 underneath the raiment 10. Vest 11 is fitted onto a person 12 by portions 40, 42 and 44 and straps 38a and 38b. More specifically, vest 11 has a first portion 40 covering at least part of the chest of a person 12. Portion 40 is akin to a shield. Portion 40 may be used to protect the person 12 in the course of simulating trauma events and responses to trauma events. Accordingly, it may be made of rigid material, such as polyurethane resin or resin coated.

Vest 11 has a second portion 42 attached to the first portion 40 and forms a cavity 34 in the general area between the first and second portions 40, 42. Vest 11 also has third and fourth side portions 44 attached to the first portion 40 and covering at least part of the sides of the torso of a person 12. Portions 44 may be integrated into portion 40, such as being one continuous portion. Portions 44, 42 and 40 may also be integrated together into one piece constituting the major component of vest 11, other than straps 38. Portions 40, 42 and 44 may also be attached by various conventional mechanical means such as adhesives, fasteners, welding, melding and other joiners. Portions 40, 42 and 44 are preferably constructed of composite or plastic material, but other and additional materials may also be used, such as silicon material that contains nylon fibers, carbon fibers, other composite materials and latex and other rubber materials.

As shown in FIGS. 2A and 2B, portions 40 and 44 have front and back sides 70, 72. In general, the back sides 72 face towards person 12 and the front sides 70 face away from person 12. As also indicated in FIGS. 2A, 2B and 2C, front side 70 of portions 40 and 42 may be colored or textured to mimic or otherwise resemble the internal cavity of the torso of a body.

Also, as shown in FIGS. 2A, 2B and 2C, portion 42 is preferably made as an artificial rib cage 32. As such, portion 42, as rib cage 32, is a prosthetic resembling a human rib cage. Portion 42, including as rib cage 32, is positioned against the inner surface 22 of the raiment 10 (see also FIGS. 3A, 3B, 4) to simulate a skeletal structure. As also shown, at least one prosthetic internal organ 36 (e.g., intestine 30) is positioned within the cavity 34 of the vest 11.

The one or more prosthetic internal organs 36 (e.g., intestine 30 as shown in FIGS. 2A, 2B, and 2C; lungs 46, heart 48, stomach 50, kidneys 52, bladder 54, liver 56, diaphragm 60 and spleen 62 as shown in FIGS. 4 and 5) are attached to vest 11 by fittings, adhesives, fasteners, welding, melding and other joiners. Alternatively, one or more prosthetic internal organ 36 may be positioned within cavity 34 of vest 11 without attachment to vest 11.

5

As further shown in FIGS. 2A, 2B and 2C, the vest 11 is intended to cover at least a part of the front of the torso of a person 12 and to fit over the person's shoulders or around the person's neck by straps 38a and around the torso of the person by straps 38b. Straps 38a are secured to portion 40 of vest 11 and may be secured together or to other straps by various well known means (e.g., buckles, ties, Velcro, etc.). Straps 38b are secured to portion 40 or 44 of vest 11 and may be secured together or to straps 38a in the same fashion.

The structural aspects of the raiment 10 will be more fully appreciated by referencing FIGS. 3A and 3B. There it will be seen that layer 20 of the raiment 10 has inner surface 22 in addition to an outer surface 24. FIGS. 3A and 3B show that the layer 20 of raiment 10 can be formed with one or more reservoirs 26 for holding the blood-like fluid 18 therein. As shown, reservoirs 26 may be embedded in raiment 10 between inner and outer surfaces 22 and 24 or covered by raiment 10. Reservoirs 26 may constitute any shape, including generally rectangular or circular pockets (over the right chest area of person 12 in FIG. 3A), strand like pockets (over the stomach area of person 12 in FIG. 3A) or separate containers (over the left shoulder of person 12 in FIG. 3A). Reservoirs 26 may be attached to raiment 10 by fluid channels 28. Fluid channels 28 preferably constitute flexible tubing mounted under the outer surface 24 of the raiment 10 and may extend and join to reservoirs 26 proximate to or distant from the raiment 10. Tubing for fluid channels 28 may be of predetermined length. Fluid channels 28 constituting such tubing may be positioned against the inner surface 22 of the raiment 10 with a portion thereof juxtaposed with at least one orifice 16. For example, a fluid channel 28 is provided to connect the reservoir 26 in fluid communication with the orifice 16 for use in simulating a penetrating internal wound. Importantly, the reservoir 26 is positioned so it can be squeezed by a hand of a limb of the person 12 who is wearing the raiment 10. Reservoir 26 may be also positioned to be manipulated by the person 12 wearing the raiment 10 to expel blood like fluid 18 in alternative ways, such as by applying pressure with a limb to the reservoir 26 or by changing the position of person 12. This will then cause a portion of blood-like fluid 18 to be expelled from the reservoir 26 and through the orifice 16 to simulate bleeding. As shown, wound simulator 14 may be further aligned with orifice 16 to further simulate the injury, wound or other trauma event.

As shown further in FIG. 3B, reservoir 26 may be filled with blood like fluid 18 and may further be refillable via conventional means, such as filling fluid 18 into reservoir 26 via the same opening for connection of reservoir 26 to channel 28. Or reservoir 26 may be a separate container or pocket with a separate opening for filling reservoir 26 with fluid 18. As such, reservoir 26 may be used to expel fluid 18 for multiple uses. Reservoirs 26 are also preferably replaceable for multiple uses of simulator 13 to simulate multiple trauma events.

Referring back to FIG. 1, it will be appreciated that wound simulator 14 can be juxtaposed with the orifice 16 to simulate a bleeding abrasion. On the other hand, the orifice 16 can be presented as a puncture wound, substantially as shown in FIG. 1, without a surrounding wound simulator 14. By further example, orifice 16 can also present an opening to the cavity 34 of vest 11 to display and access one or more prosthetic internal human organs 36 during simulation of a penetrating wound to the human body. As intended for the present invention, the orifice 16 and the wound simulator 14 can be located anywhere on the raiment 10, as desired, to simulate a plurality

6

of different wound/injury presentations. Also, the wound simulator 14 can be used alone to simulate gas or liquid agent injuries.

In addition to the superficial wound/injury presentations disclosed above, the present invention also envisions presentations for internal injuries. Specifically, with reference to FIGS. 4 and 5, it will be seen that the present invention includes various prostheses for use in simulating wounds/injuries that might be received in a trauma event. These prostheses include: a prosthetic intestine 30, a prosthetic rib cage 32, prosthetic lungs 46, a prosthetic heart 48, a prosthetic stomach 50, prosthetic kidneys 52, a prosthetic bladder 54, prosthetic liver 56, prosthetic diaphragm 60 and a prosthetic spleen 62. In detail, for example, the prosthetic intestine 30 is a length of flexible hosing that is made to resemble a real intestine. Such flexible hosing may be used as fluid channel 28 or reservoir 26 to selectively expel blood like fluid 18. Alternatively, fluid channel 28 and reservoir 26 may be selectively attached to the hosing of intestine 30 to simulate bleeding from the intestine 30 during simulation of a trauma event. Similar arrangements can be made with respect to any of the organs 36.

Preferably, the prosthetic internal organs 36 (30, 46, 48, 50, 52, 54, 56, 60, 62) and rib cage 32 are made from composite, plastic or rubber materials. These prostheses of internal organs 36 (30, 46, 48, 50, 52, 54, 56, 60, 62) are most preferably made of composite materials such as open or closed cell polyurethane foam of various densities, elasticity, and deformation characteristics to simulate internal organs. Other and additional materials may also be used, such as silicon material that contains nylon fibers, carbon fibers, other composite materials and latex and other rubber materials. The prosthetic rib cage 32 is preferably made from rigid material, such as rigid polyurethane resin material. In use, both the prosthetic rib cage 32 and any desired combination of prosthetic internal organs (30, 46, 48, 50, 52, 54, 56, 60, 62) are positioned between the body of the person 12 (actor) who is wearing the raiment 10, and the inner surface 22 of the raiment 10 within the cavity 34 of the vest 11.

As shown in FIG. 4, and also in connection with FIGS. 3A and 3B, internal prosthetic organ(s) 36 may be positioned proximate to at least one orifice 16 and at least one fluid reservoir 26 for simulation of a penetrating wound to the human torso. In use, the raiment 10 of the present invention can be used with any combination of superficial wounds/injuries disclosed above. Specifically, there may be a plurality of reservoirs 26, with a corresponding number of orifices 16. Likewise, a plurality of wound simulators 14 can be used.

The prosthetics of organs 36 (i.e. intestine 30, rib cage 32, lungs 46, heart 48, stomach 50, kidneys 52, bladder 54, liver 56, diaphragm 60, spleen 62 (see FIG. 5) and thorax described below may, or may not, be used, as desired. The prosthetic organs 36 may be combined within the cavity 34 in various combinations to simulate wounds and injuries. FIG. 4 shows a preferred embodiment including a large group or package of organs 36. Further, the prosthetic organs 36 may be combined into such packages and formed to represent certain wounds and injuries. For example, a package may be assembled to simulate injuries to the lungs 46 and heart 48 and another package may be assembled to simulate injuries to the stomach 50 and liver 56. The prosthetic organs 36 and packages of prosthetic organs are interchangeable so that various injury scenarios can be simulated. The wound simulators 14, orifices 16, channels 28 and reservoirs 26 are similarly interchangeable and positionable in alternative arrangements so that various injury scenarios can be simulated. And, as explained above, the positions of the wound simulators 14, orifices 16,

channels **28**, reservoirs **26** and organs **36** may be selectively juxtaposed to simulate various wounds and injuries. Collectively, the component elements of the present invention are intended to be used to simulate or mimic the various wounds/injuries that are likely to be received by a person involved in a traumatic event.

As shown in FIG. **6**, in alternative embodiments, penetrating injuries to the thorax can also be simulated by mounting a prosthetic thorax **80** under or on the raiment **10** in the area of the neck of the person **12**. In detail, the prosthetic thorax **80** is held on a bib **81** by retaining straps **82a** and **82b**, and the bib **81** is mounted or fitted around the neck of person **12**. For example, bib **81** can have straps, ties, Velcro or other fasteners to secure bib **81** at the back of the neck of person **12**. The prosthetic thorax **80** and bib **81** can fit underneath or over raiment **10**. Structurally, the prosthetic thorax **80** includes an elongated hollow tube-like member **84** that has an open end **86** and a closed end **88**. For use, the tube **84** is presented on the bib **81**, and the bib **81** is positioned on the throat of the person **12** with the open end **86** positioned for receipt of a cricothyroid tube (not shown). Thus, the prosthetic thorax **34** can be used for simulating an invasive surgical placement of a cricothyroidotomy. Operationally, the tube-like member **40** is held on the raiment **10** to mimic a thorax, and to present its open end **86** for access thereto with a chest tube during a simulation of a penetrating wound to the thorax. These prostheses can be made of plastic, rubber or composite materials, such as open or closed cell polyurethane foam of various densities, elasticity, and deformation characteristics to simulate internal organs.

Use of the wearable partial task surgical simulator **13** as a teaching aid is accomplished by using the simulator **13** on a person **12** who portrays an injured person in a trauma event. The simulator **13** dynamically simulates the wounds and injuries the person **12** received during the simulated traumatic event. The simulator **13** is set up to simulate a trauma event among various possible scenarios. Simulator **13** allows verbal and gesticular interaction between person **12** wearing the simulator **13** and a first responder (e.g. trainee, trainer, other participant) who is treating the person **12** wearing the simulator **13**.

Accordingly, in using the partial task surgical simulator **13** as a teaching aid, the raiment **10** is provided with at least one wound simulator **14** related to the simulated trauma event and at least one fluid reservoir **26** for holding a blood-like fluid **18** and is in fluid communication with at least one orifice **16**. The vest **11** is provided on person **12** underneath the raiment **10** and provides simulation of the internal skeletal structure (e.g., rib cage **32**) and internal organs (e.g., prosthetic organs **36**) of the person **12** simulating injury in the trauma event. Person **12** selectively expels the blood-like fluid **18** from the reservoir **26** and through the orifice **16** to simulate the trauma event. Simulator **13** is used to mimic a penetrating wound by positioning a predetermined length of flexible tubing (e.g., intestine **30** or fluid channel **28**) against the inner surface **22** of the raiment **10** with a portion thereof juxtaposed with the orifice **16** of at least one superficial wound. At least one fluid reservoir **26** is attached to a length of flexible tubing (e.g., fluid channel **28**) attached to the raiment **10** and reservoir **26** is manipulated to expel blood-like fluid **18**. A first responder selectively accesses at least one prosthetic internal human organ **36** in the cavity **34** through at least one orifice **16** of the raiment **10** during simulation of a penetrating wound to the human body. The prosthetic human internal organs **36** are selected from among multiple combinations of prosthetic human internal

organs **36** and used in the cavity **34** of the vest **11** to simulate from among various internal organ structure injuries involved in a selected trauma event.

While the particular Wearable Partial Task Surgical Simulator as herein shown and disclosed in detail is fully capable of obtaining the objects and providing the advantages herein before stated, it is to be understood that it is merely illustrative of the presently preferred embodiments of the invention and that no limitations are intended to the details of construction or design herein shown other than as described in the appended claims.

What is claimed is:

1. A wearable device for simulating a trauma event comprising:

a raiment dimensioned to cover the torso of a person, wherein the raiment is formed as a layer having an inner surface and an outer surface, and wherein the outer surface has a color and a texture comparable to human skin, and further wherein the raiment has at least one fluid reservoir for holding a blood-like fluid therein and is formed with at least one orifice on the outer surface thereof in fluid communication with the reservoir for selectively expelling the blood-like fluid from the reservoir and through the orifice to simulate the trauma event; and

a vest dimensioned to fit on the torso of a person underneath the raiment, wherein the vest has a first portion covering at least part of the chest of a person, a second portion attached to the first portion and forming a cavity generally between the first and second portions, and third and fourth side portions attached to the first portion and covering at least part of the sides of the torso of a person.

2. The device as recited in claim 1 wherein the wearable device for simulating a trauma event is configured to provide a protective layer to protect a person wearing the wearable device from being physically harmed by a simulation of trauma events and a response to trauma events.

3. The device as recited in claim 2 wherein the inner surface of the raiment is configured to act as a shield to protect the person wearing the wearable device for simulating a trauma event.

4. The device as recited in claim 2 wherein the first portion of the vest is configured to protect the person wearing the wearable device for simulating a trauma event.

5. The device as recited in claim 1 wherein the blood-like fluid is expelled as patches, spots, drops, drips, puddles, and ooze spots.

6. The device as recited in claim 1 wherein the first portion and second portion are constructed from composite materials, latex, nylon fibers, carbon fibers, rubber, or rubber-like material.

7. The device as recited in claim 1 wherein the cavity is colored or textured to resemble the internal cavity of a human body.

8. The device as recited in claim 1 further comprising multiple reservoirs wherein the multiple reservoirs are connected by way of a fluid channel.

9. The device as recited in claim 1 further comprising at least one prosthetic internal organ positioned within said cavity.

10. The device as recited in claim 9 wherein the reservoir is selectively attached to the at least one prosthetic organ to simulate bleeding from the prosthetic organ during simulation of the trauma event.

11. The device as recited in claim 9 wherein the at least one prosthetic internal organ is intestines, lung, heart, stomach, kidney, bladder, liver, diaphragm, spleen, and ribs.

12. The device as recited in claim 9 wherein the at least one prosthetic internal organ is colored or textured to simulate a real internal human organ.

* * * * *