



(12) **United States Patent**  
**Amling et al.**

(10) **Patent No.:** **US 7,471,310 B2**  
(45) **Date of Patent:** **Dec. 30, 2008**

(54) **INTELLIGENT CAMERA HEAD**

(75) Inventors: **Marc R. Amling**, Santa Barbara, CA (US); **David Chatenever**, Santa Barbara, CA (US)

(73) Assignee: **Karl Storz Imaging, Inc.**, Goleta, GA (US)

(\* ) Notice: Subject to any disclaimer, the term of this patent is extended or adjusted under 35 U.S.C. 154(b) by 1128 days.

(21) Appl. No.: **10/033,316**

(22) Filed: **Dec. 28, 2001**

(65) **Prior Publication Data**

US 2004/0201686 A1 Oct. 14, 2004

(51) **Int. Cl.**

**H04N 5/232** (2006.01)  
**A61B 1/04** (2006.01)

(52) **U.S. Cl.** ..... **348/72**; 600/118; 348/211.14

(58) **Field of Classification Search** ..... 348/65, 348/72-74, 211.14; 600/109, 112, 118, 129, 600/175

See application file for complete search history.

(56) **References Cited**

**U.S. PATENT DOCUMENTS**

- 4,963,960 A 10/1990 Takami
- 5,007,408 A 4/1991 Ieoka
- 5,010,876 A 4/1991 Henley et al.
- 5,239,983 A 8/1993 Katsurada
- 5,242,315 A 9/1993 O'Dea
- 5,419,717 A 5/1995 Abendschein et al.
- 5,575,757 A 11/1996 Kennedy et al.
- 5,702,345 A 12/1997 Wood et al.
- 5,852,697 A 12/1998 Williams et al.

- 5,896,166 A 4/1999 D'Alfonso et al.
- 5,978,651 A 11/1999 Eto et al. .... 455/5.1
- 6,046,769 A \* 4/2000 Ikeda et al. .... 348/222.1
- 6,219,091 B1 \* 4/2001 Yamanaka et al. .... 348/65
- 6,295,082 B1 9/2001 Dowdy et al. .... 348/72
- 6,313,868 B1 11/2001 D'Alfonso et al.
- 6,390,972 B1 \* 5/2002 Speier et al. .... 600/112
- 6,449,007 B1 \* 9/2002 Yokoyama .... 348/73
- 6,573,931 B1 \* 6/2003 Horii et al. .... 348/211.14
- 6,638,212 B1 \* 10/2003 Oshima .... 600/109
- 6,707,490 B1 \* 3/2004 Kido et al. .... 348/211.14
- 6,753,901 B1 \* 6/2004 Takahashi et al. .... 348/65
- 6,836,290 B1 \* 12/2004 Chung et al. .... 348/294
- 6,870,566 B1 \* 3/2005 Koide et al. .... 348/296
- 6,975,351 B2 \* 12/2005 Ikeda et al. .... 348/211.14
- 7,316,646 B2 \* 1/2008 Amling et al. .... 600/109

**FOREIGN PATENT DOCUMENTS**

FR 2 767 004 7/1997  
WO 99/55082 10/1999

**OTHER PUBLICATIONS**

Interface Circuits for TIA/EIA-644 (LVDS) Design Notes, Copyright 1998, Texas Instruments Incorporated.

\* cited by examiner

*Primary Examiner*—David L Ometz  
*Assistant Examiner*—Dillon Durnford-Geszvain  
(74) *Attorney, Agent, or Firm*—St. Onge Steward Johnston & Reens LLC

(57) **ABSTRACT**

A video imaging system that minimizes the effect of EMI on the image data, provides a small, lightweight easy to use camera head, permitting interchangeable use of a variety of intelligent camera heads with a single camera control unit, and allows the utilization of new camera heads with new functions as they become available without having to replace the existing CCU.

**26 Claims, 7 Drawing Sheets**

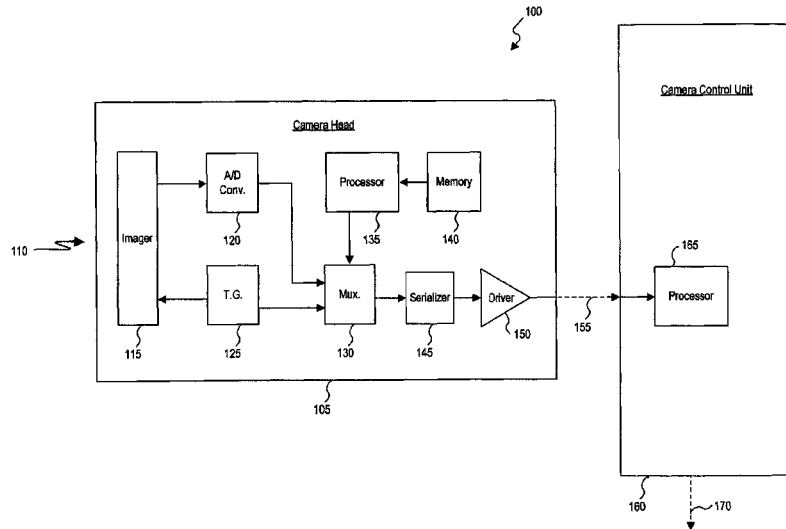

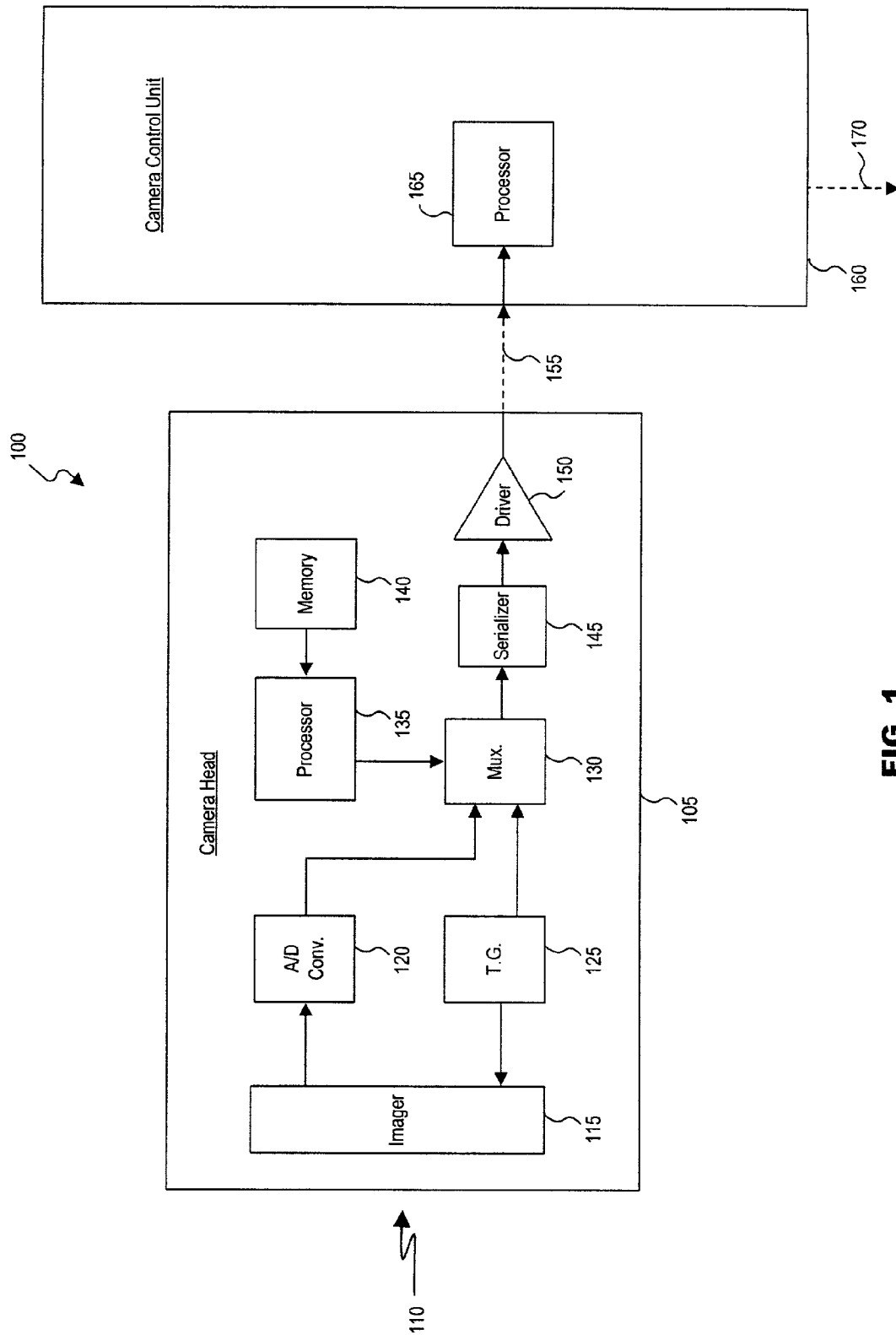

FIG. 1

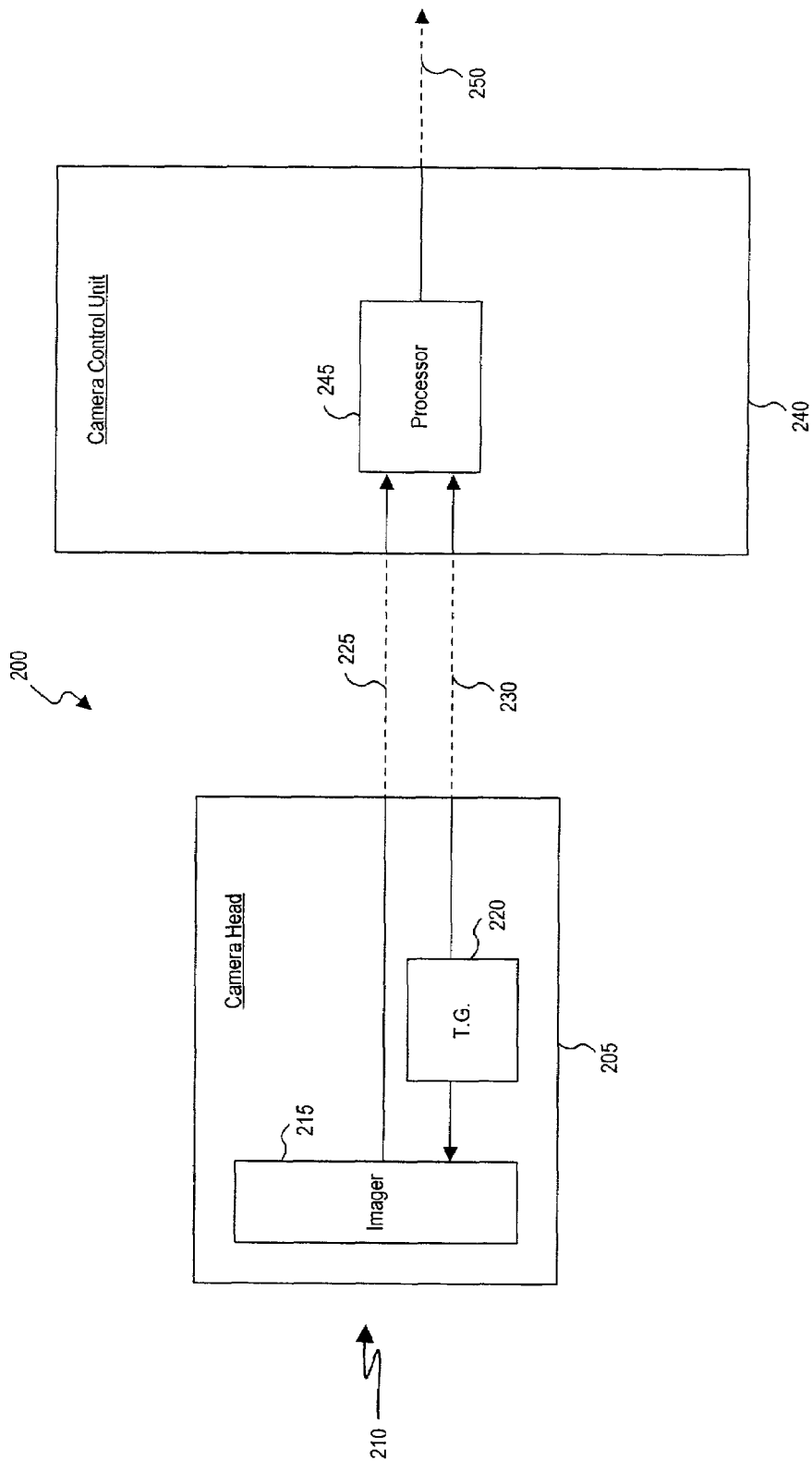

FIG. 2

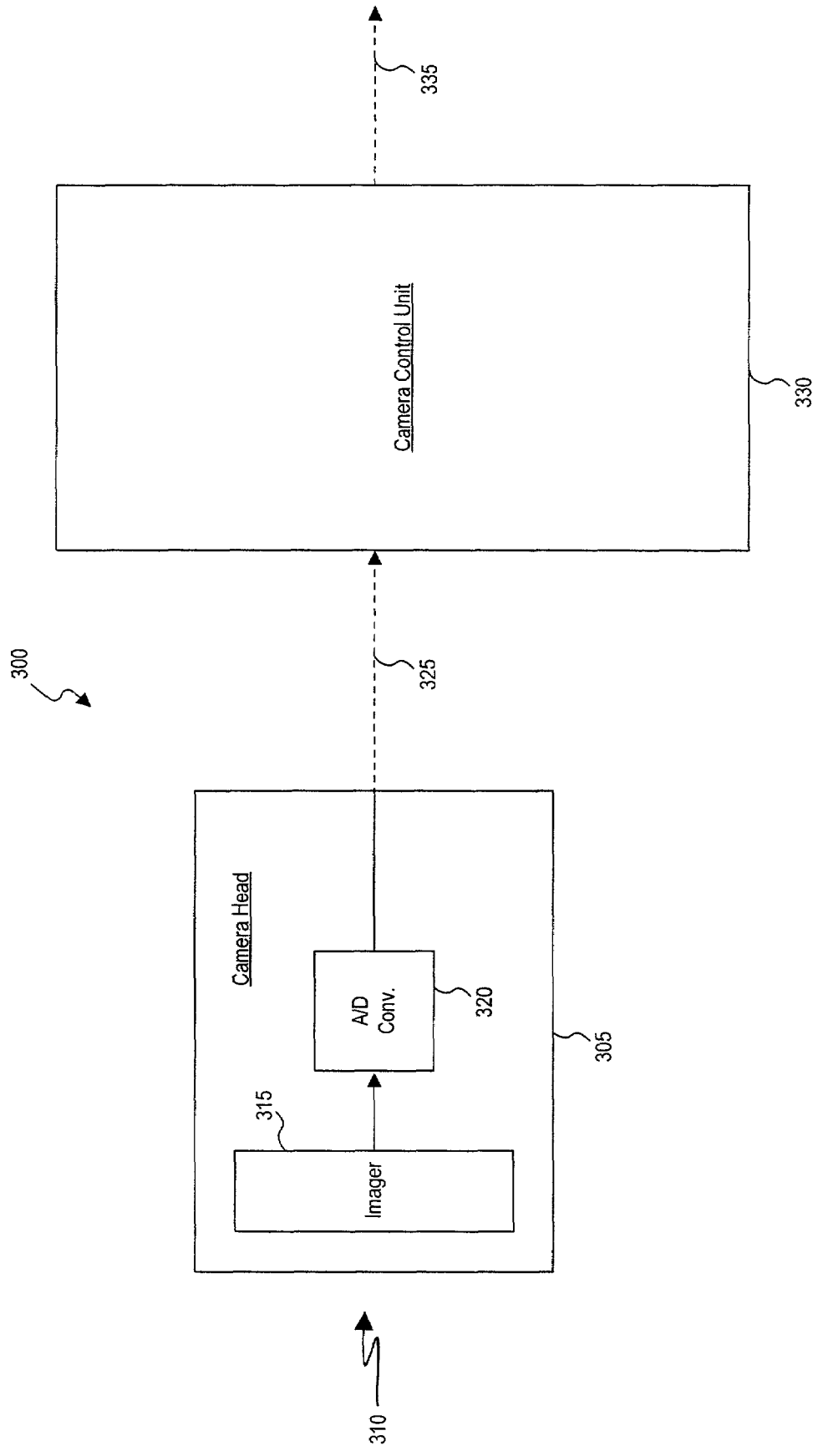

FIG. 3

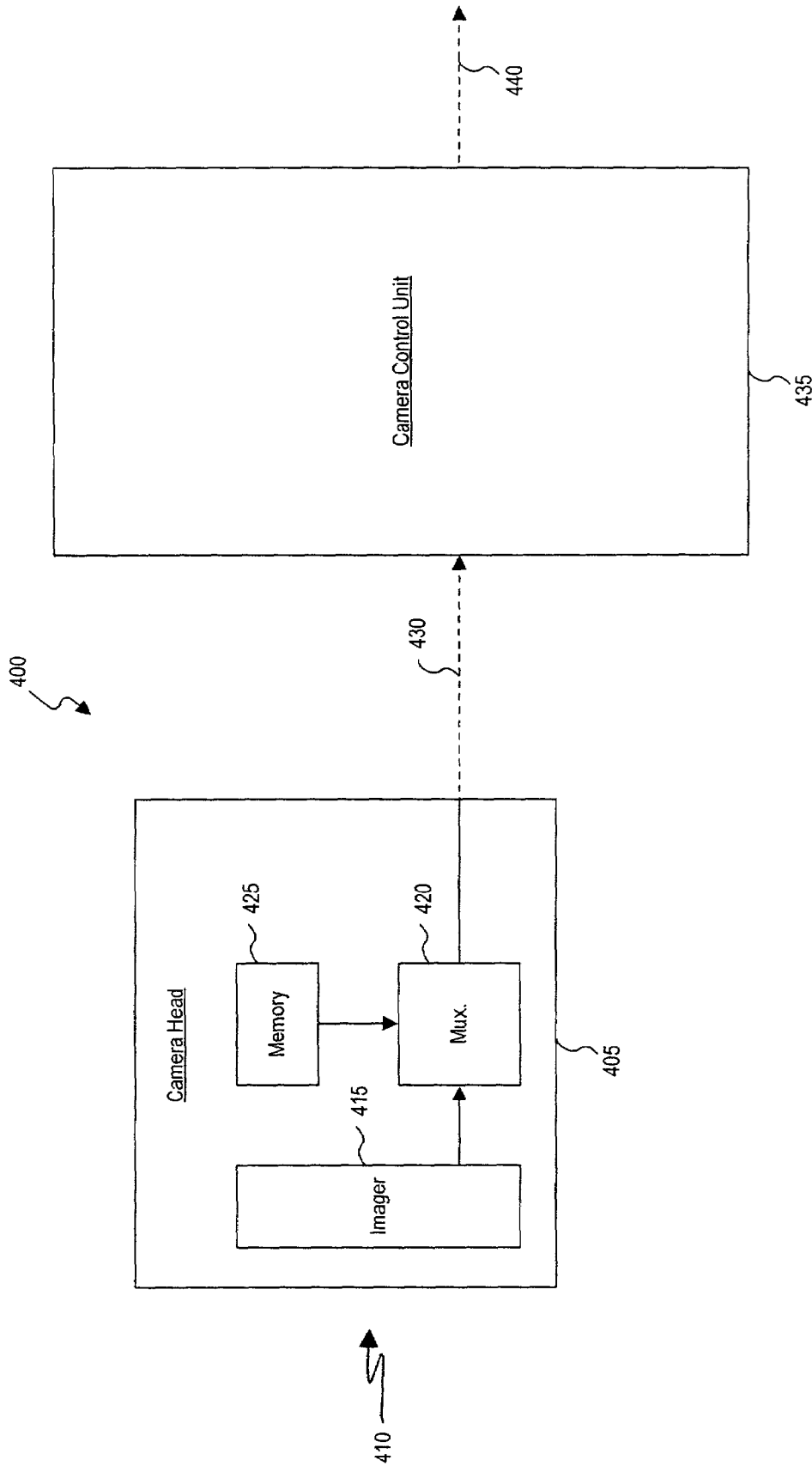

FIG. 4

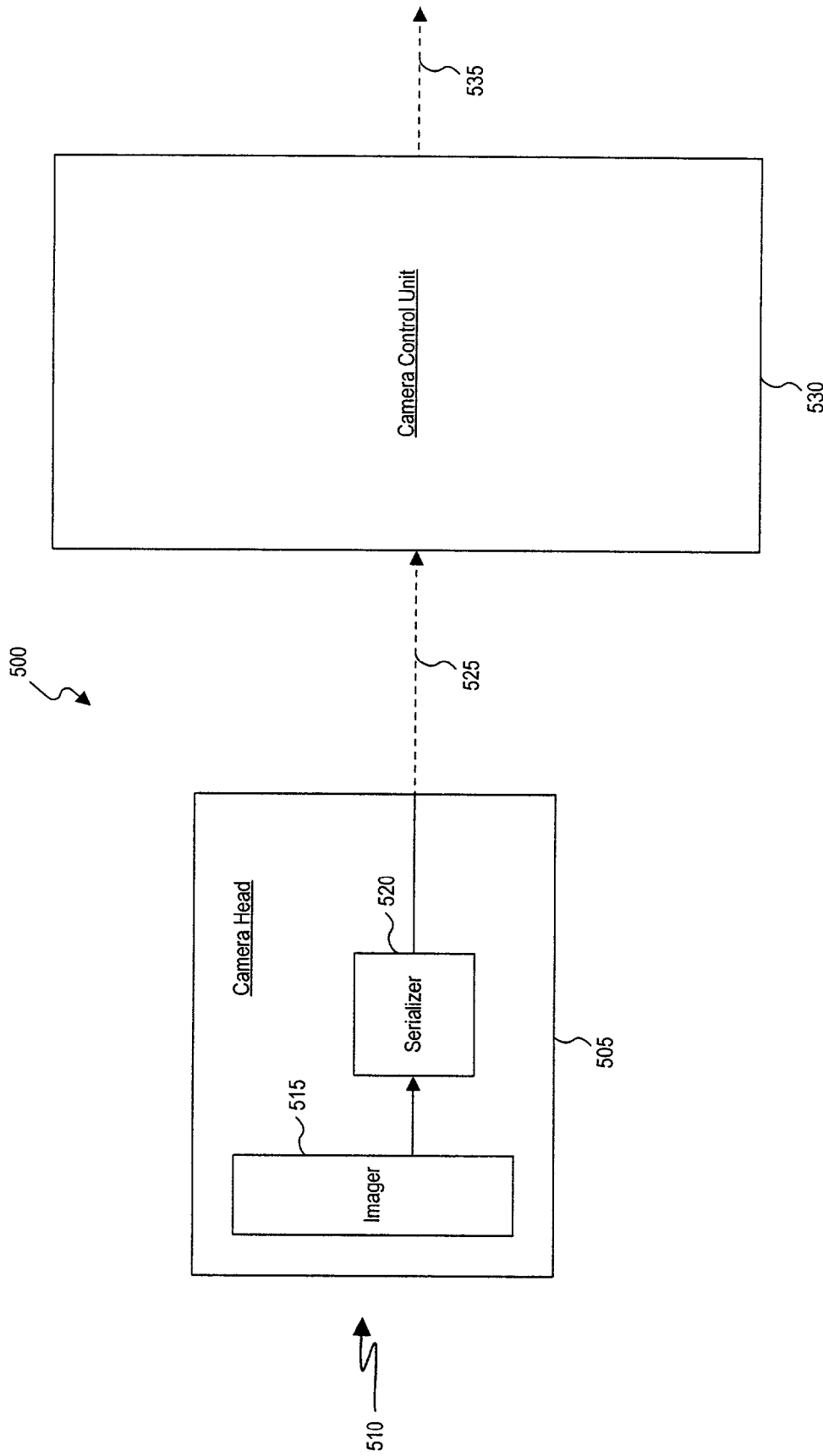

FIG. 5

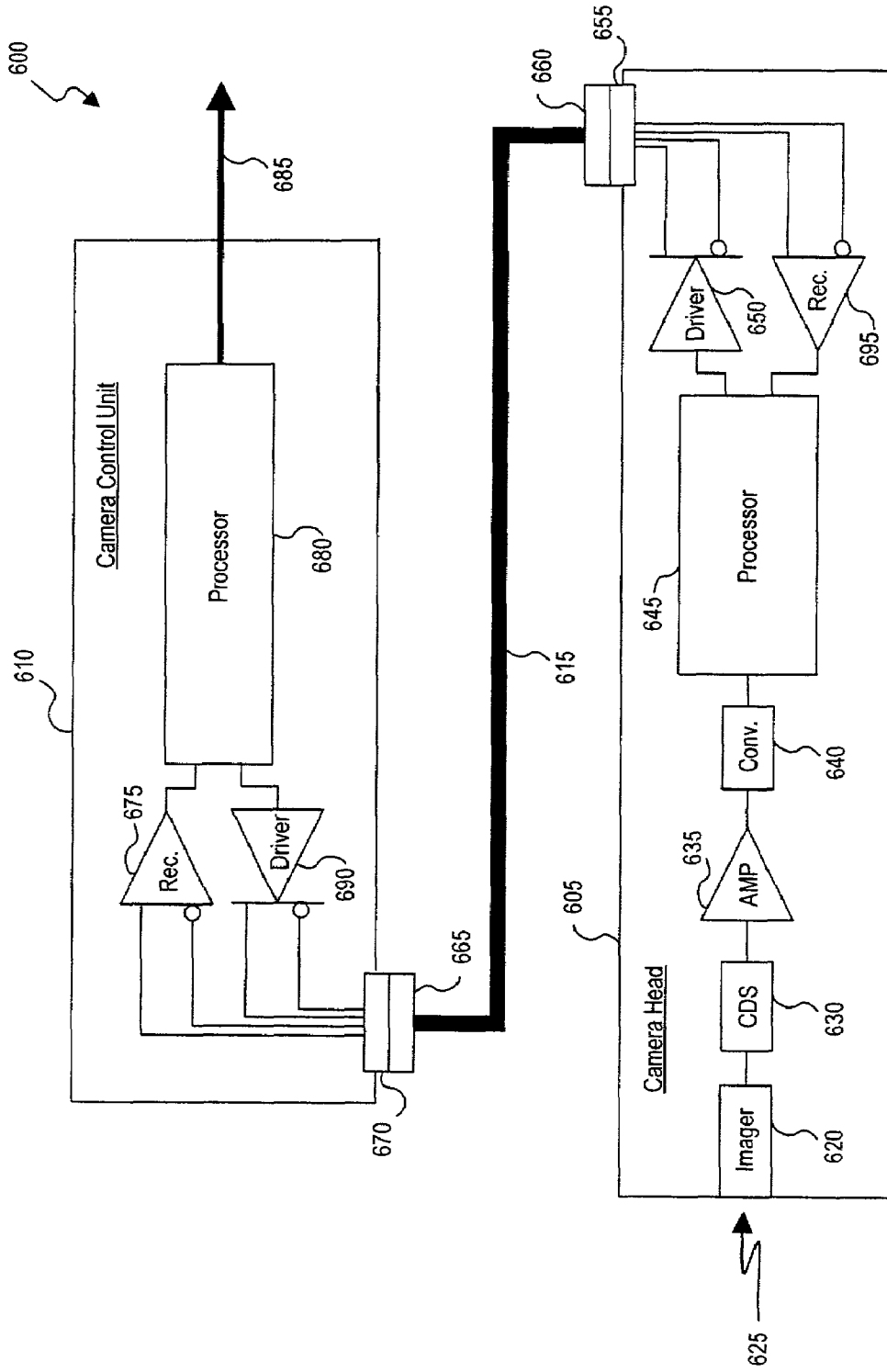
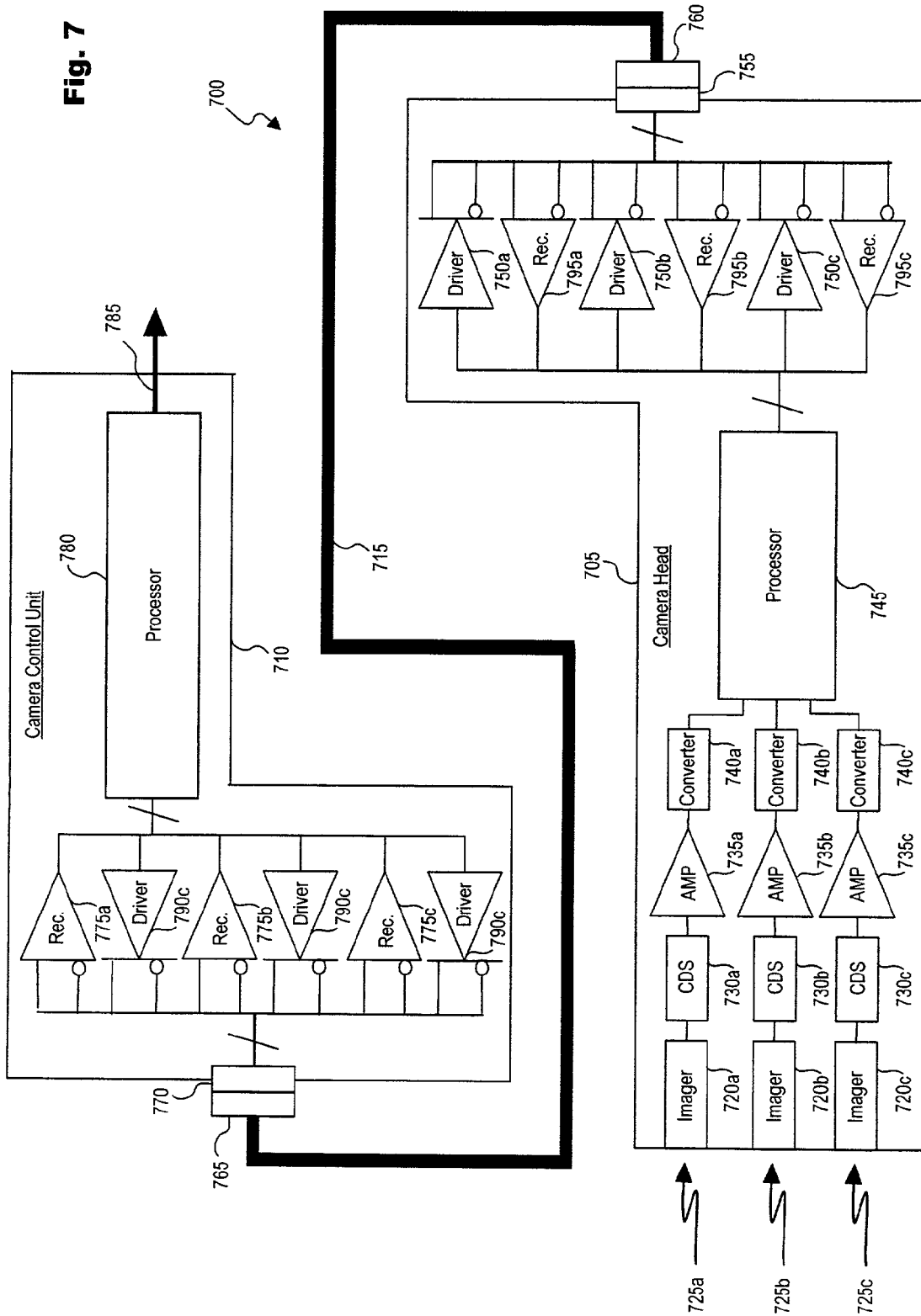

Fig. 6





**INTELLIGENT CAMERA HEAD**

## FIELD OF THE INVENTION

The invention relates to a camera head having components permitting its interchangeable use with a variety of camera control units.

## BACKGROUND OF THE INVENTION

The field of video endoscopy, to which the present invention generally relates, includes medical diagnostic and therapeutic disciplines that utilize endoscopes to penetrate and view otherwise inaccessible body cavities utilizing minimally invasive surgical procedures. Coupling of video imaging cameras (incorporating solid-state imagers) to endoscopes, for image reproduction, has become standard within the field. Endoscopic video cameras (hereinafter referred to as "camera heads"), are most advantageously small and lightweight for ease of use by medical personnel, and typically incorporate either single or multiple solid-state imagers. Some special purpose endoscopes have integrated (built-in) solid-state imagers, which do not facilitate direct viewing of internal body cavities by medical personnel without an accompanying video imaging system and display. To achieve the desired size and weight, camera head and/or integrated endoscope-camera assembly electronics are typically separated physically from the majority of circuitry required to process and output high-quality, color video images.

Typically, endoscopic camera heads are sterilized prior to each use, because camera heads and endoscopes enter the "sterile field" during a surgical procedure. Camera control units ("CCUs"), which contain the majority of the electronic circuitry required to process video images, are typically not sterilized, and are placed on or in carts, or permanently wall-mounted. In known video imaging systems, interconnection is achieved by means of a cable, with usually one cable end permanently fixed to the camera head, while the other cable end is detachably connected to the CCU using a connector. Similar to the camera head itself, it is advantageous that cables be small in diameter and lightweight, but rugged enough to withstand repeated sterilization, accidental gurney wheel "run-over," and the like.

Known video imaging systems typically include at least one camera head with a fixed cable, and often either a CCU having various input connections or different CCUs for each camera type. The input connections to the CCU are keyed so that specific camera heads can only be connected to a specific one of various inputs or to a particular CCU that corresponds to that particular camera head specifications. Timing signals, video system function command signals, and camera head supply voltages are all generated in the CCU for transmission to the camera head. The advantage to this camera head arrangement is small size, lightweight and easy maneuverability. Disadvantageously, only camera heads requiring timing signals matched to the CCUs timing generator may be utilized with this arrangement. Therefore, new or differing camera heads utilizing different timing signals cannot be utilized.

Another disadvantage of known video imaging systems is that the various camera heads have differing cable structures based upon the camera head parameters. Each camera head typically is matched to its own specifically configured cable.

Existing interconnections between camera heads and CCUs typically comprise dedicated parallel wires to provide greater data carrying capacity. It is meant by "dedicated parallel wires" that each specific signal is transmitted by means

of an individual wire, either single for power and control signals or shielded coax for image data, between a camera head and CCU. However, a disadvantage of providing dedicated parallel wires is that typically twenty to thirty separate lines are required to control, energize and receive image data from camera heads, with most signal lines requiring a dedicated connector pin. The more lines required, the greater the diameter, size and corresponding weight of the cable bundle. The larger this bundle becomes, the more likely it is to interfere with medical personnel's use of the video imaging system. Moreover, utilizing dedicated parallel wire type cabling is undesired when additional functionality is required and added to either the camera head or CCU. To accommodate this new functionality, additional wiring must be incorporated in the cable bundle, requiring equipment redesign and subsequent purchase by customers. Also, as video imaging systems develop, CCUs are becoming programmable for compatibility with various types of camera heads, are adding new control features and are processing different types of video signals.

Another aspect of video imaging systems is that undesired image "noise" can be encountered, due to stray electromagnetic signals being induced upon the wires of the cable bundle (commonly referred to as electromagnetic interference, "EMI"), and from signal "cross-talk" within the cable itself. Known video imaging systems utilize analog signals for transmitting video and other signals to or from camera heads and CCUs. These analog signals, especially image data, are very susceptible to EMI from surgical electro-cautery equipment and the like. The use of EMI shielding is prohibitive due to the added cost and subsequent cable size and weight increase. Moreover, the desired endoscopic camera head cable length itself (typically 10 feet or more) tends to induce noise as analog signals are propagated down its length.

Additionally, solid-state imaging devices of higher resolution are becoming available and commercially feasible for use in video imaging systems. As imagers increase in sophistication, greater amounts of image data must be transmitted by means of the interconnection cable between camera heads and CCUs, and thus higher speed data transmission means must be utilized.

What is desired, therefore, is to provide a video imaging system where interconnection of camera heads is not limited to only those camera heads compatible with the timing signals generated in the CCU. Rather, a video imaging system is desired that enables the CCU to process image data and receive control signals from, and to issue command signals to, many types of camera heads, each having differing timing signal requirements.

It is further desired to provide a video imaging system that is resistant to both internal and external electromagnetic interference that does not require utilization of heavy shielding. This advantageously will enable the use of a small diameter, lightweight cable.

It is further desired to provide a video imaging system enabling camera heads and CCUs to take advantage of new features and functions without requiring redesign and/or replacement of the system. Such a configuration would provide the ability to accommodate future video camera system improvements and adaptations as current technology limitations are overcome, without obsolescing initial customer investments in CCUs.

It is further desired to provide a video imaging system that enables the use of a single pair of wires for transmission of control, command and image data transmission from and to the camera head and the camera control unit.

## SUMMARY OF THE INVENTION

These and other objects of the invention are achieved in one advantageous embodiment by providing a video imaging system comprising: a camera control unit for processing a digital image signal; a cable, connected to said camera control unit, for transmitting the digital image signal to said camera control unit; and a camera head, connected to said cable, for providing the digital image signal, said camera head including: an imager, for generating an analog image signal; a timing generator, for actuating said imager; a converter, for converting the analog image signal into the digital image signal; and a serializer, for serializing the digital image signal for transmission over said cable.

In another advantageous embodiment a video imaging system is provided comprising: a camera control unit for processing an image signal; a cable, connected to said camera control unit, for transmitting the image signal to said camera control unit; and a camera head, connected to said cable, for providing the image signal, said camera head including: an imager, for generating the image signal; and a timing generator, for actuating said imager.

In a further advantageous embodiment a video imaging system is provided comprising: a camera control unit for processing a digital image signal; a cable, connected to said camera control unit, for transmitting the digital image signal to said camera control unit; and a camera head, connected to said cable, for providing the digital image signal, said camera head including: an imager, for generating an analog image signal; and a converter, for converting the analog image signal into the digital image signal.

In yet another advantageous embodiment a video imaging system is provided comprising: a camera control unit for processing an image signal; a cable, connected to said camera control unit, for transmitting the image signal to said camera control unit; and a camera head, connected to said cable, for providing the image signal, said camera head including: an imager, for generating an image signal; and a serializer, for serializing the image signal for transmission over said cable.

In still another advantageous embodiment a video imaging system is provided comprising: a camera control unit for processing an image signal, a cable, connected to said camera control unit, for transmitting the image signal to said camera control unit, and a camera head, connected to said cable, for providing the image signal, said camera head including: an imager, for generating the image signal; and a processor.

In a further advantageous embodiment a video imaging system is provided having a small diameter, lightweight, universal cable configuration, utilizing low-voltage differential signals (“LVDS”). Although various other signal methods may be used, LVDS based architecture is preferred due to its low power consumption, high-speed data transfer rate, two-wire unidirectional connectivity, and high resistance to internal (cross-talk) and external electromagnetic interference. The cable architecture is designed to reliably transmit and receive data from different camera heads to CCUs, as well as accommodate the differing technical requirements of different camera heads.

The cable has also been provided to accommodate the use of programmable CCUs. For instance, a camera head is connected by means of the universal cable to a programmable CCU. Software executing on the programmable CCU verifies connection to the camera head and retrieves camera head information relating specifically to that camera head. Camera head information may include command and control data comprising: software programs, operating information, timing signal data, camera head identification information, cam-

era use information and the like. Control signals include any signal transmitted from the camera head except image data, such as timing signals generated by the timing generator, and signals generated by the processor. Command signals include any signal transmitted from the camera control unit to the camera head.

The architecture of the universal cable also greatly increases the data carrying capacity of the cable connection between the various CCUs and the varying camera heads. This need for increased data carrying capacity can be achieved by means of data multiplexing, while still maintaining the desired small diameter, and weight of a single cable. What is meant by “data multiplexing” is that any single signal path can be utilized for transmitting multiple data streams on a time-sharing basis. The new cable architecture will also allow for a greater cable length while not sacrificing data carrying capacity or inducing signal noise.

In a further advantageous embodiment a video imaging system is provided where the digital camera head comprises at least one processing device used to receive parallel digital video data and compress the data into a digital serial data stream for reception by at least one digital serial driver; and to receive digital serial data from at least one digital serial receiver. The programming flexibility realized using at least one processing device (such as, but not limited to, field programmable gate arrays, computer programmable logic devices, digital signal processors, and microprocessors) provides the necessary speed, precision, and adaptability desired for endoscopic video camera applications. Moreover, camera head physical size, production costs, and power consumption considerations are further mitigated by using a processor based video data compression and conversion configuration, instead of using discrete multiplexing devices. Additionally, as imager technologies improve, the invention can be easily adapted, by means of programming revision, to further exploit those improvements.

The invention and its particular features and advantages will become more apparent from the following detailed description considered with reference to the accompanying drawings.

## BRIEF DESCRIPTION OF THE DRAWINGS

FIG. 1 is a block diagram illustrating an embodiment of the video imaging system—including the camera head, universal cable and camera control unit.

FIG. 2 is a block diagram illustrating an embodiment of the video imaging system—including the camera head, universal cable and camera control unit.

FIG. 3 is a block diagram illustrating an embodiment of the video imaging system—including the camera head, universal cable and camera control unit.

FIG. 4 is a block diagram illustrating an embodiment of the video imaging system—including the camera head, universal cable and camera control unit.

FIG. 5 is a block diagram illustrating an embodiment of the video imaging system—including the camera head, universal cable and camera control unit.

FIG. 6 is a block diagram illustrating an embodiment of the endoscopic system, the universal cable interconnecting a single imager camera head with a CCU.

FIG. 7 is a block diagram illustrating an embodiment of the endoscopic system, the universal cable interconnecting a multiple imager camera head with a CCU.

## DETAILED DESCRIPTION OF THE DRAWINGS

FIG. 1 illustrates an advantageous embodiment of the video imaging system 100. A camera head 105 is provided having an imager 115 for receiving photonic energy 110 reflected off a viewed object (not shown). The imager 115 utilizes timing signals generated in timing generator 125 to develop output analog image data corresponding to the received photonic energy 110. The imager 115 converts the received photonic energy 110 to output analog image data received by analog-to-digital converter 120. The analog-to-digital converter 120 in turn converts the received analog image data to digital image data. The digital image data is then fed into multiplexer 130. The timing generator 125 also provides an input to multiplexer 130. A processor 135, having access to a memory device 140 is also located in the camera head 105. The processor 135 may send camera information stored in memory device 140 to multiplexer 130. The multiplexer 130, multiplexes the various received input signals, generating a multiplexed digital signal. The output of multiplexer 130 is connected to serializer 145, also located in camera head 105. The output of serializer 145 is then connected to digital serial driver 150. The output of digital serial driver 150 is coupled to camera control unit 160 via coupling element 155. Camera control unit 160 processes the received signal via processor 165. The processor 165 utilizes timing signals generated in timing generator 125 to process the received image data in order to generate video output 170.

FIG. 2 illustrates an advantageous embodiment of the video imaging system 200. A camera head 205 is provided having an imager 215 for receiving photonic energy 210 reflected off a viewed object (not shown). The imager 215, located in camera head 205, utilizes timing signals generated in timing generator 220, also located in camera head 205, to develop output image data corresponding to the received photonic energy 210.

The output of imager 215 is coupled to processor 245, located in camera control unit 240, via coupling element 225. In addition, an output from timing generator 220 is coupled to processor 245, located in camera control unit 240, via coupling element 230. Processor 245 utilizes timing signals generated in timing generator 220 to process the received image data in order to generate video output 250.

FIG. 3 illustrates an advantageous embodiment of the video imaging system 300. A camera head 305 is provided having an imager 315 for receiving photonic energy 310 reflected off a viewed object (not shown). The imager 315 develops output analog image data corresponding to the received photonic energy 310. The imager 315 converts the received photonic energy 310 to output analog image data received by analog-to-digital converter 320. The analog-to-digital converter 320 in turn converts the received analog image data to digital image data. The output of analog-to-digital converter 320 is then coupled to camera control unit 330 via coupling element 325. Camera control unit 330 processes the received digital image data to generate video output 335.

FIG. 4 illustrates an advantageous embodiment of the video imaging system 400. A camera head 405 is provided having an imager 415 for receiving photonic energy 410 reflected off a viewed object (not shown). The imager 415 develops output image data corresponding to the received photonic energy 410. The imager 415 converts the received photonic energy 410 to output image data received by multiplexer 420, also located in camera head 405. A memory device 425, located in the camera head 405, is also coupled to multiplexer 420. The multiplexer 420, multiplexes the vari-

ous received input signals, generating a multiplexed signal. The output of multiplexer 420 is coupled to camera control unit 435 via coupling element 430. Camera control unit 435 processes the received signal to generate video output 440.

FIG. 5 illustrates an advantageous embodiment of the video imaging system 500. A camera head 505 is provided having an imager 515 for receiving photonic energy 510 reflected off a viewed object (not shown). The imager 515 develops output image data corresponding to the received photonic energy 510. The imager 515 converts the received photonic energy 510 to output image data received by serializer 520, also located in camera head 505. The output of serializer 520 is coupled to camera control unit 530 via coupling element 525. Camera control unit 530 processes the received signal to generate video output 535.

FIG. 6 illustrates an advantageous embodiment the video imaging system 600, as applied to a single solid-state imager camera head 605, and CCU 610. The video imaging system 600 includes a universal cable 615, which connects camera head 605 to CCU 610. Solid-state imager 620 receives photonic energy 625 reflected off a viewed object (not shown). Imager 620, being a charge coupled device ("CCD"), charge injection device ("CID"), or complementary metal oxide semiconductor ("CMOS") device, or the like, converts the photonic energy into a representative analog voltage, which is received by correlated double sampler ("CDS") 630. Amplifier 635 receives the analog output of CDS 630. The output of amplifier 635 is analog image data varying in accordance with the output of imager 620 in reference to the gain level setting of amplifier 635. The analog image data output from amplifier 635 is received by analog-to-digital ("A/D") converter 640, which outputs a stream of digital image data (by means of a plurality of parallel lines) corresponding to the "varying" analog image data output by amplifier 635. CDS 630, amplifier 635, and A/D converter 640 can be discrete devices, but it is preferred that all be integrated into a single device, and more preferred to utilize a device such as, but not limited to, Exar, part no., XRD98L59 Image Digitizer, or National Semiconductor, part no. LM98501 or LM98503 Camera Signal Processors. Such integrated devices are in common use within the video camera head field.

Processor 645 receives the parallel digital image data output by A/D converter 640, to compress the data into a digital serial data stream for reception by digital serial driver 650. Processor 645 can be, but is not limited to, a processor type such as field programmable gate arrays, computer programmable logic devices, digital signal processors, and microprocessors. Processor 645 outputs digital serial image data, which is received by digital serial driver 650. Although various other digital serial drivers may be used, a low-voltage differential signal driver is preferred, for reasons previously detailed, and more preferred is to utilize a device such as, but not limited to, Texas Instruments, part no. SN65LVDS1 High-Speed Differential Driver. The output of digital serial driver 650 is connected to first connector 655.

Universal cable 615 is terminated at a second end with a second connector 660. To provide interconnection between camera head 605 and CCU 610 via universal cable 615, the second connector 660 is secured to first connector 655. Further, a third connector 665 is provided for securing to a fourth connector 670. The input to digital serial receiver 675 is connected to a fourth connector 670. Although various other digital serial receivers may be used (necessarily being compatible with digital serial driver 650), a low voltage differential signal receiver is preferred, for reasons previously detailed, and more preferred to utilize a device such as, but not limited to, Texas Instruments, part no. SN65LVDS2 High-

Speed Differential Receiver. The output of digital serial receiver **675** is connected to image processing circuitry **680**, for eventual output of image data **685**. Image data **685** for display on a video monitor or other video equipment (not shown), as is common within the field.

A further function provided in this advantageous embodiment is the ability to send control and/or command signals to, and write information to the camera head **605** via processor **645**. The input to digital serial driver **690** is connected to image processing circuitry **680** and the output of digital serial driver **690** is connected to the fourth connector **670**. In this manner, information and data may be transmitted to the camera head **605** via the universal cable **615**. In the camera head **605**, the input to digital serial receiver **695** is connected to the first connector **655** for receiving the transmitted information and/or data from digital serial driver **690**. In addition, the output to digital serial receiver **695** is connected to processor **645** to effect control and/or command signals and to store data.

FIG. 7 illustrates the video imaging system **700**, as applied to a multiple solid-state imager camera head **705**, and CCU **710**. The video imaging system **700** includes, a universal cable **715**, which connects camera head **705** to CCU **710**. Common within the field, multiple imagers are affixed to a prism assembly (not shown), which splits received photonic energy (**725a**, **725b**, and **725c**) into three separate wavelength bands (red, blue and green, in the case of visible light camera systems), which are then detected by the solid-state imagers (**720a**, **720b**, and **720c**). This configuration produces higher resolution images than a single imager configuration. Solid-state imagers (**720a**, **720b**, and **720c**) receive photonic energy (**725a**, **725b**, and **725c**) from a prism assembly (not shown). Imagers (**720a**, **720b**, and **720c**) being a CCD, CID, or CMOS device, or the like, convert the photonic energy (**725a**, **725b**, and **725c**) into representative analog voltages, which are received by CDS (**730a**, **730b**, and **730c**). Analog outputs of CDS (**730a**, **730b**, and **730c**) are received by amplifiers (**735a**, **735b**, and **735c**). The output analog image data of amplifiers (**735a**, **735b**, and **735c**) vary in accordance with the output of imagers (**720a**, **720b**, and **720c**) in reference to the gain level setting of amplifiers (**735a**, **735b**, and **735c**). The analog image data output from amplifiers (**735a**, **735b**, and **735c**) is received by A/D converters (**740a**, **740b**, and **740c**), which each output a stream of digital image data (by means of a plurality of parallel lines) corresponding to the "varying" analog image data outputs by amplifiers (**735a**, **735b**, and **735c**). CDS **730a**, amplifier **735a** and A/D **740a** (as well as CDS **730b** and **730c**, amplifiers **735b** and **735c**, and A/Ds **740b** and **740c**) can be discrete devices, but it is preferred that all be integrated into a single device, and more preferred to utilize a device such as, but not limited to, Exar, part no., XRD98L59 Image Digitizer, or National Semiconductor, part no. LM98501 or LM98503 Camera Signal Processors. Such integrated devices are in common use within the video camera field.

Processor **745** receives the parallel digital image data, to compress the data into a digital serial data stream for reception by digital serial drivers (**750a**, **750b**, and **750c**). Processor **745** can be, but is not limited to, a processor type such as field programmable gate arrays, computer programmable logic devices, digital signal processors and microprocessors. Processor **745** outputs digital serial image data, which is received by digital serial drivers (**750a**, **750b**, and **750c**). Although various other digital serial drivers may be used, low-voltage differential signal drivers are preferred, for reasons previously detailed, and more preferred is to utilize a device such as, but not limited to, Texas Instruments, part no.

SN65LVDS1 High-Speed Differential Driver. The outputs of digital serial drivers (**750a**, **750b**, and **750c**) are connected to second connector **755**.

Universal cable **715** is terminated with a first connector **760** at the first end. To provide interconnection between camera head **705** and CCU **710** via universal cable **715**, first connector **760** is secured to second connector **755**, and a third connector **765**, which is terminated on the second end of cable **715**, is secured to fourth connector **770**. Digital serial receivers (**775a**, **775b**, and **775c**) inputs are connected to fourth connector **770**. Although various other digital serial receivers may be used (necessarily being compatible with digital serial drivers (**750a**, **750b**, and **750c**), low voltage differential signal receivers are preferred, for reasons previously detailed, and more preferred is to utilize a device such as, but not limited to, Texas Instruments, part no. SN65LVDS2 High-Speed Differential Receiver. The outputs of digital serial receiver (**775a**, **775b**, and **775c**) are attached to video processing circuitry **780**, for eventual output of video signal **785**. Video signal **785** is intended to be displayed on a video monitor or other video equipment (not shown), as is common within the field.

A further function provided in this advantageous embodiment is the ability to send control and/or command signals to, and write information to the camera head **705** via processor **745**. The input to digital serial drivers (**790a**, **790b**, **790c**) is connected to image processing circuitry **780** and the output of digital serial drivers (**790a**, **790b**, **790c**) is connected to fourth connector **770**. In this manner, information and data may be transmitted to the camera head **705** via the universal cable **715**. In camera head **705**, the input to digital serial receivers (**795a**, **795b**, **795c**) is connected to second connector **755** for receiving the transmitted information and/or data from digital serial drivers (**790a**, **790b**, **790c**). In addition, the output to digital serial receivers (**795a**, **795b**, **795c**) is connected to processor **745** to effect control and/or command signals and to store data.

The video imaging systems **600** (**700**) in FIGS. 6 and 7 have been designed to accommodate anticipated future data carrying requirements. Endoscope systems will, most likely, continue to become more flexible. For instance, CCUs are becoming programmable for compatibility with various types of cameras, are adding new control features, and are processing differing image signals.

In view of this, the video imaging systems **600** (**700**) have been designed to effectively transmit data between different camera heads and CCUs in order to utilize programmable CCUs. As depicted in FIGS. 6 and 7, digital serial drivers **650** (**750a**, **750b** and **750c**) and digital serial receivers **675** (**775a**, **775b** and **775c**) provide this data capability. In like manner to digital serial drivers/receivers **650** (**750a**, **750b** and **750c**) and **675** (**775a**, **775b** and **775c**), various digital serial drivers and receivers may be utilized, but a low-voltage differential signal driver and receiver are preferred, for reasons previously detailed, and more preferred to utilize devices such as, but not limited to, Texas Instruments, part no. SN65LVDS1 High-Speed Differential Driver and part no. SN65LVDS2 High-Speed Differential Receiver.

As depicted in FIG. 7, digital serial drivers (**750a**, **750b** and **750c**; and **690a**, **690b** and **690c**), and digital serial receivers (**775a**, **775b** and **775c**; **695a**, **695b** and **695c**) are provided for expanded data and control capabilities as future video imaging system improvements are realized.

As depicted in FIGS. 6 and 7, to eliminate the need for a different cable type for each camera head configuration, the universal cable **615** (**715**) is designed to be compatible with a variety of camera heads. A generic universal cable **615** (**715**) would be used for both multiple and single image sensor

9

cameras **605 (705)**. This would be accomplished by providing a universal cable **615 (715)** with sufficient data carrying capacity to accommodate a multi-imager digital camera, as depicted in FIG. 7. If the same cable were utilized with a single imager digital camera, as depicted in FIG. 6, then the signal paths not being utilized would not be connected within the camera. Therefore, a single generic universal cable **615 (715)** is usable with a variety of camera heads, eliminating the need to stock a specific cable for differing video imaging system types.

Although the invention has been described with reference to a particular arrangement of parts, features and the like, these are not intended to exhaust all possible arrangements or features, and indeed many other modifications and variations will be ascertainable to those of skill in the art.

What is claimed is:

1. A video imaging system comprising:
  - a camera control unit processing a continuous stream of digital video data;
  - a cable, connected to said camera control unit, for transmitting the stream of digital video data to said camera control unit; and
  - a camera head, connected to said cable, for providing the stream of digital video data, said camera head including:
    - an imager, for generating an analog stream of video data;
    - a timing generator, generating a timing signal particular to said camera head, the timing signal actuating said imager and sent to said camera control unit;
    - a converter, for converting the analog stream of video data into the stream of digital video data;
    - a serializer, for serializing the stream of digital video data for transmission over said cable;
    - at least one digital serial driver;
    - a processor; and
    - a memory device, accessible by said processor, containing camera head information;
- said camera control unit having at least one digital serial receiver and is controlled based at least in part upon said timing signal particular to said camera head.
2. The video imaging system according to claim 1 wherein said camera head further comprises a multiplexer, for generating a multiplexed signal, which includes the digital image signal and control signals.
3. The video imaging system according to claim 1 wherein said camera head utilizes at least one digital serial receiver.
4. Said camera head according to claim 3 wherein the at least one digital serial receiver utilizes Low-Voltage Differential Signals.
5. Said camera head according to claim 1 wherein the at least one digital serial driver utilizes Low-Voltage Differential Signals.
6. The video imaging system according to claim 1 wherein said camera control unit utilizes at least one digital serial driver.
7. Said camera control unit according to claim 6 wherein the at least one digital serial driver utilizes Low-Voltage Differential Signals.
8. Said camera control unit according to claim 1 wherein the at least one digital serial receiver utilizes Low-Voltage Differential Signals.
9. A video imaging system comprising:
  - a camera control unit processing a continuous stream of digital video data;
  - a cable, connected to said camera control unit, for transmitting the stream of digital video data to said camera control unit; and
  - a camera head, connected to said cable, for providing the stream of digital video data, said camera head including;

10

- an imager, for generating the stream of digital video data;
  - a timing generator, generating a timing signal particular to said camera head, the timing signal actuating said imager and sent to said camera control unit;
  - at least one digital serial driver;
  - a processor; and
  - a memory device, accessible by said processor, containing camera head information;
- said camera control unit having at least one digital serial receiver and is controlled based at least in part upon said timing signal particular to said camera head;
- wherein a plurality of camera heads, each with differing timing signals, are attachable to and controlled by said camera control unit.

10. The video imaging system according to claim 9 wherein said camera head produces analog image data, said camera head further comprising a converter, for converting an analog image signal to a digital image signal.

11. The video imaging system according to claim 9 wherein said camera head further comprises a multiplexer, for generating a multiplexed signal, which includes the image signal and control signals.

12. The video imaging system according to claim 9 wherein said camera head further comprises a serializer, for serializing the image signal.

13. The video imaging system according to claim 9 wherein said at least one digital serial driver utilizes Low-Voltage Differential Signals.

14. The video imaging system according to claim 9 wherein said at least one digital serial receiver utilizes Low-Voltage Differential Signals.

15. A video imaging system comprising:

- a camera control unit processing a continuous stream of digital video data;
- a cable, connected to said camera control unit, for transmitting the stream of digital video data to said camera control unit; and
- a camera head, connected to said cable, for providing the stream of digital video data, said camera head including:
  - an imager, for generating an analog stream of video data;
  - a converter, for converting the analog stream of video data into the stream of digital video data;
  - a serializer, for serializing the stream of digital video data
- a processor; and
- a memory device, accessible by said processor, containing camera head information.

16. The video imaging system according to claim 15 wherein said camera head further comprises a multiplexer, for generating a multiplexed signal, which includes the digital image signal and control signals.

17. The video imaging system according to claim 15 wherein an inputted data formats the camera control unit.

18. The video imaging system according to claim 17 wherein the inputted data comes from the camera head.

19. The video imaging system according to claim 15 wherein said camera head utilizes at least one digital serial driver utilizing Low-Voltage Differential Signals.

20. The video imaging system according to claim 15 wherein said camera control unit utilizes at least one digital serial receiver utilizing Low-Voltage Differential Signals.

21. A video imaging system comprising:

- a camera control unit processing a continuous stream of digital video data;
- a cable, connected to said camera control unit, for transmitting the stream of digital video data to said camera control unit; and

**11**

a camera head, connected to said cable and an endoscope, for providing the stream of digital video data, said camera head including;  
an imager, including an analog to digital converter for generating the stream of digital video data;  
a serializer, for serializing the stream of digital video data for continuous transmission over said cable  
a processor; and  
a memory device, accessible by said processor, containing camera head information.

**22.** The video imaging system according to claim **21** wherein said camera head further comprises a multiplexer, for generating a multiplexed signal, which includes the image signal and control signals.

**12**

**23.** The video imaging system according to claim **21** wherein an inputted data formats the camera control unit.

**24.** The video imaging system according to claim **23** wherein the inputted data comes from the camera head.

**25.** The video imaging system according to claim **21** wherein said camera head utilizes at least one digital serial driver utilizing Low-Voltage Differential Signals.

**26.** The video imaging system according to claim **21** wherein said camera control unit utilizes at least one digital serial receiver utilizing Low-Voltage Differential Signals.

\* \* \* \* \*